



HARGRAVES

Mooreville, North Carolina 28117
T: 704-662-3500 F: 704-662-8744
www.hargravestfluidics.com

Part No.: **E165-11-090**
Model No.: **A.1F16N1.G09VDC**
Description: **CTS Diaphragm Pump,
Coreless Motor**

Dimensional Layout:

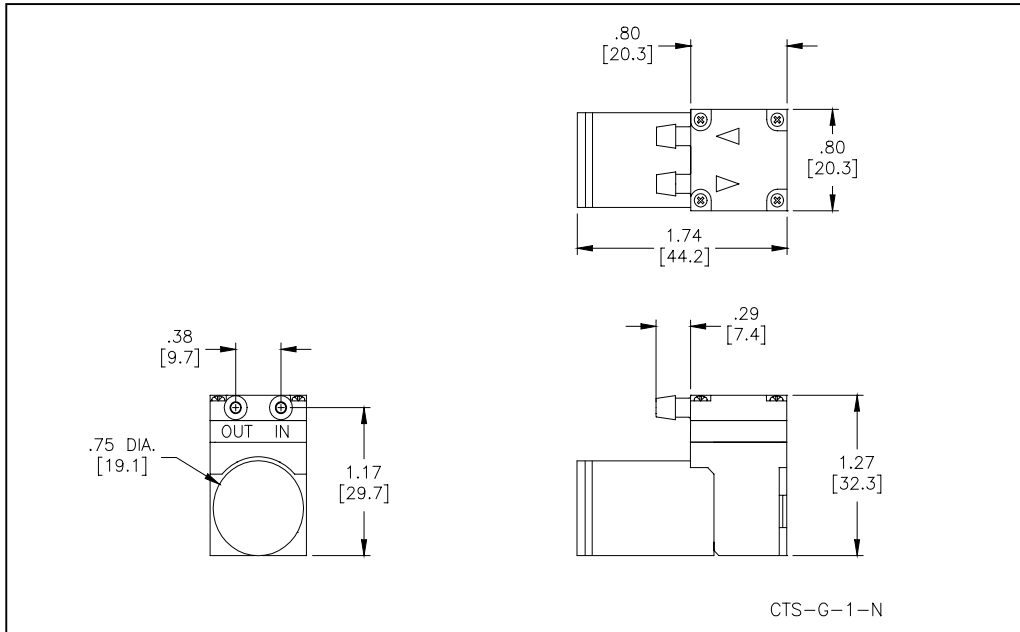

Specifications:

- | | | | | | | |
|-----------------------------|------------------------|-------------------|-----------------------|----------------------------------|--|-----------|
| 1. Wetted Materials: | Pump Head: | Polysulfone | 3. Electrical: | Motor: | Coreless Dual Bearing | |
| | Retainer Washer: | Polysulfone | | Operating Voltage: | 9.0 VDC | |
| | Retainer Screw: | 18-8 Stainless | | In-rush Current: | 5 x Operating Current for up to 50 ms | |
| | Valves: | EPDM [65] | | Recommended Fusing: | Slow Blow @ 2 x Operating Current | |
| | Diaphragm: | AEPDM [F80] | | | | |
| 2. Performance: | | <u>Continuous</u> | <u>Maximum</u> | 4. Other: | Temperature Range: | 5 - 50° C |
| | - Pressure: PSIG [Air] | 16.5 | 16.5 | | Free Flow RPM: | 8350 |
| | - Vacuum: in Hg [Air] | 16.5 | 16.5 | | Eccentric: | E350 |
| | | | | 5. Operating Limitations: | N/A | |

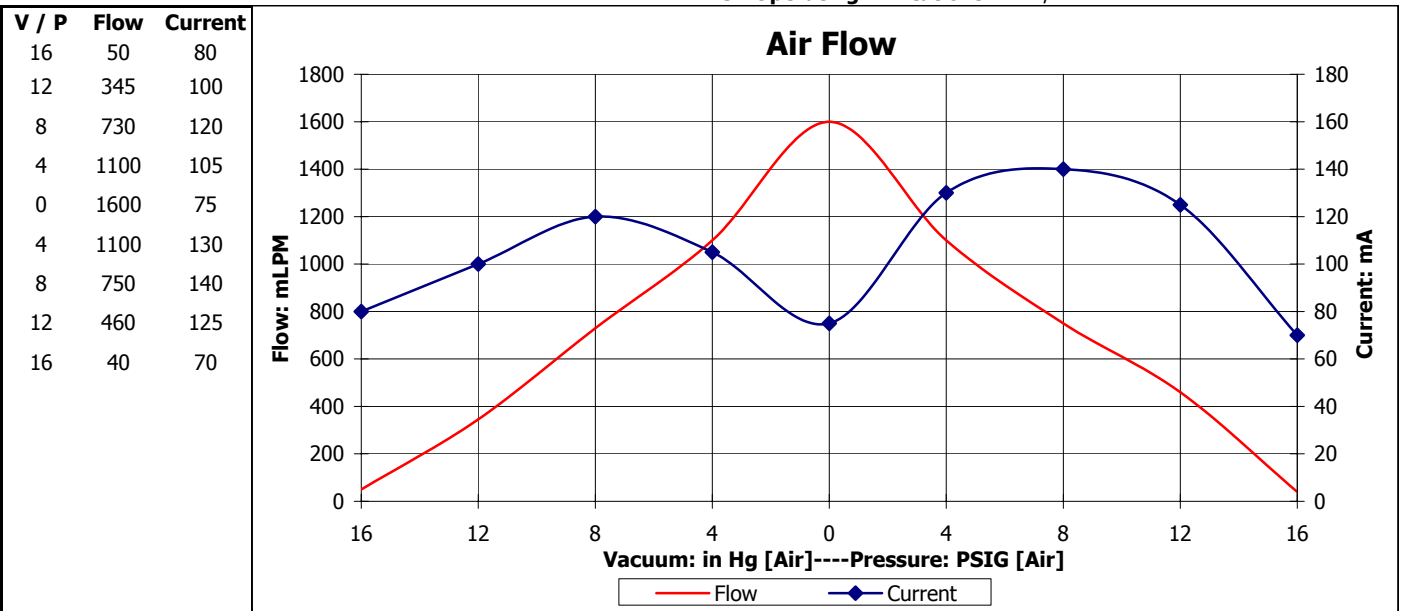

The above graph denotes nominal performance at 800' above sea level, 24°C, and at the specified voltage.

ST