

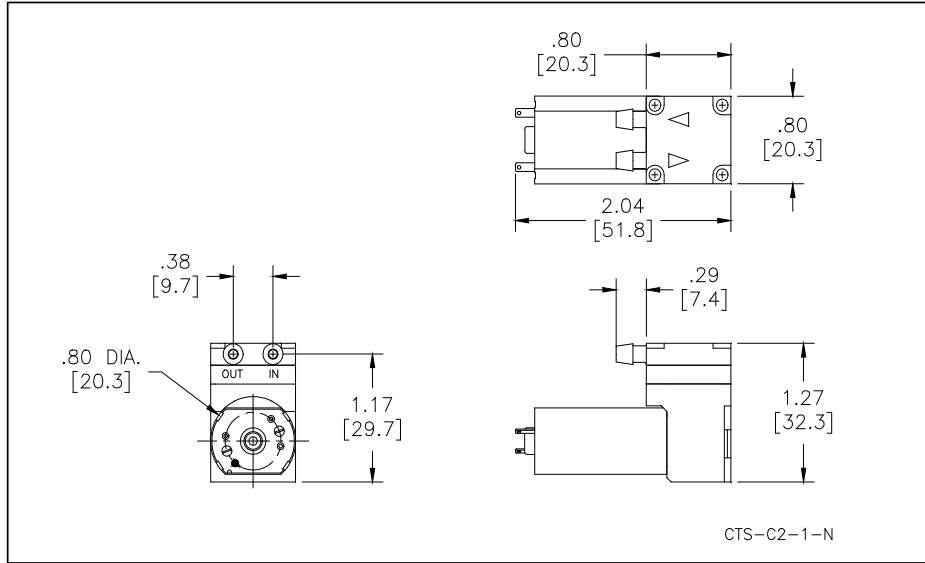

Mooresville, North Carolina 28117
 T: 704-662-3500 F: 704-662-8744
 www.hargravesfluidics.com

Part No.: **E193-11-120**
 Model No.: **A.1F09N1.C12VDC**
 Description: **CTS Diaphragm Pump,
 Brush Motor**

Dimensional Layout:



Specifications:

- | | | | | | |
|-----------------------------|------------------|----------------|-----------------------|---------------------|---------------------------------------|
| 1. Wetted Materials: | Pump Head: | Polysulfone | 3. Electrical: | Motor: | Brush Sleeve Bearing |
| | Retainer Washer: | Polysulfone | | Operating Voltage: | 12.0 VDC |
| | Retainer Screw: | 18-8 Stainless | | In-rush Current: | 5 x Operating Current for up to 50 ms |
| | Valves: | EPDM [65] | | Recommended Fusing: | Slow Blow @ 2 x Operating Current |
| | Diaphragm: | AEPDM [F80] | | | |
-
- | | | | | | | |
|------------------------|------------------------|-------------------|----------------|------------------|--------------------|-----------|
| 2. Performance: | | <u>Continuous</u> | <u>Maximum</u> | 4. Other: | Temperature Range: | 5 - 50° C |
| | - Pressure: PSIG [Air] | 10.0 | 10.0 | | Free Flow RPM: | 6675 |
| | - Vacuum: in Hg [Air] | 12.5 | 12.5 | | Eccentric: | E250 |
-
- 5. Operating Limitations:** N/A
- 6. Recommended Filtration:** 40 Micron media w/ a minimum surface area of .24" Sq (152mmSq)

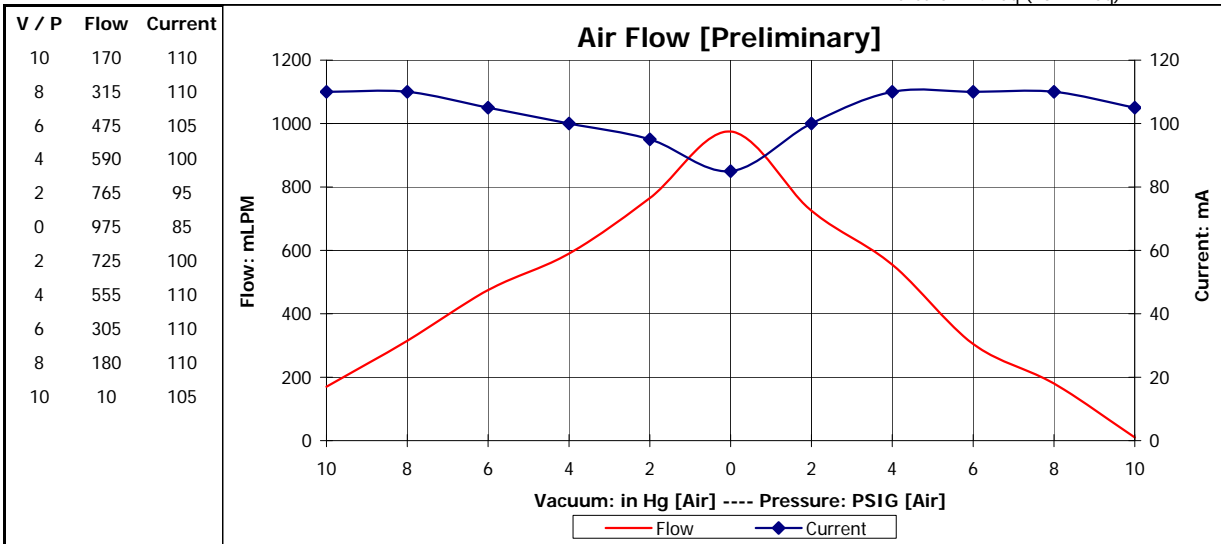

The above graph denotes nominal performance at 800' above sea level, 24°C, and at the specified voltage.

PR